SINPAR®

CATÁLOGO

**DE FRESAS DE METAL DURO INTEGRAL Y ACERO RÁPIDO,
BROCAS Y HERRAMIENTAS ESPECIALES**





TABLA DE SELECCIÓN, FRESAS PARA USO GENERAL















	pag 11	pag 13	pag 15 y 20	pag 18	pag 21	pag 23	pag 25	
								
								
FORMA DE LA PUNTA	PLANA (FRONTAL)				ESFÉRICA			
TIPO	N	N	N	N	N	N	N	
CANTIDAD DE FILOS	2	3	4	4	2	3	4	
ÁNGULO DE HELICE	30°	30°	30°	41° / 44°	30°	30°	30°	
ÁNGULO DE ATAQUE	7°	7°	7°	7°	7°	7°	7°	
CALIDAD DEL METAL DURO	MICROGRANO							

TABLA DE SELECCIÓN

FAMILIA	MATERIAL	Rm/UTS (N/mm ²)	EJEMPLO										
			FORMA DE LA PUNTA			PLANA (FRONTAL)				ESFÉRICA			
			TIPO			N	N	N	N	N	N	N	N
			CANTIDAD DE FILOS			2	3	4	4	2	3	4	4
			ÁNGULO DE HELICE			30°	30°	30°	41°/44°	30°	30°	30°	30°
			ÁNGULO DE ATAQUE			7°	7°	2°	7°	7°	7°	7°	7°
			CALIDAD DEL METAL DURO			MICROGRANO							
P	DESCRIPCIÓN	DIN	AISI										
				ACERO DE CONSTRUCCIÓN NO ALEADO	-700	St 52	1.0052	1010	●	●	●	●	●
ACERO DE FÁCIL MECANIZADO	-700	9 SMn 28	1.0715	1213	●	●	●	●	●	●	●		
ACERO DE CONSTRUCCIÓN	500-950	Ck 45	1.1191	C1045	●	●	●	●	●	●	●		
		26 CrMo4	1.7219	4132		●	●	●					
ACERO BONIFICADO, RESISTENCIA MEDIA	500-950	42 CrMo4	1.7225	4140	●	●	●	●	●	●	●		
		50CrV4	1.2241	6150	●	●	●	●					
ACERO FUNDIDO	-950	GS40	1.0416	1020	●	●	●	●	●	●	●		
ACERO DE CEMENTACIÓN	-950	16 MnCr 5	1.7131	5115/5117	●	●	●	●	●	●	●		
ACERO INOXIDABLE Y RESISTENTE A LOS ÁCIDOS, FERRÍTICO, MARTENSÍTICO	500-950	X 10 Cr 13	1.4006	410	●	●	●	●	○	●	●		
		X 12 CrMoS 17	1.4104	430F	●	●	●	●					
		X 35 CrMo 17	1.4122	440	●	●	●	●					
ACERO BONIFICADO, RESISTENCIA ALTA	950-1400	42 CrMo 4	1.7225	4140H	●	●	●	●	●	●	●		
		30 CrNiMo 8	1.6580	4340	●	●	●	●					
ACERO PARA NITRURAR, BONIFICADO	950-1400	34 CrAl 6	1.8504	--	●	●	●	●	●	○	○		
ACERO PARA HERRAMIENTAS	950-1400	X 38 CrMoV 5 1	1.2343	H11	●	●	●	●	●	○	○		
		X 155 CrVMo 12 1	1.2379	D2	●	●	●	●					
M	ACERO INOXIDABLE Y RESISTENTE A LOS ÁCIDOS, AUSTENÍTICO	500-950	X 5 CrNi 18 10	1.4307	304L	UTILIZABLES PARA OPERACIÓN DE TERMINACIÓN			●	○	○	○	
			X 10 CrNiMo 18 10	1.4571	316Ti				●				
	ACERO MARTENSÍTICO TEMPLABLE		X 3 NiCoMoTi 18 9 5	1.2709	--			○	●	○	○	○	
K	FUNDICIÓN GRIS	-550	GG25	0.6025	ASTM A48		●	●	●	○	●	●	
	FUNDICIÓN GRIS ALEADA	300-700	GGL-NiCr 35 2	0.6678	ASTM A532	●	●	●	●	○	●	●	
	FUNDICIÓN ESFEROIDAL	-500	GGG60	0.7060	ASTM A536	●	●	●	●	○	●	●	
	FUNDICIÓN MALEABLE	40-70	GTS55	0.8155	ASTM A439	●	●	●	●	○	●	●	

● Muy adecuado ○ También utilizable

FAMILIA	MATERIAL	Rm/UTS (N/mm ²)	EJEMPLO	FORMA DE LA PUNTA								
				PLANA (FRONTAL)				ESFÉRICA				
				TIPO	N	N	N	N	N	N	N	
				CANTIDAD DE FILOS	2	3	4	4	2	3	4	
				ÁNGULO DE HELICE	30°	30°	30°	41°/44°	30°	30°	30°	
				ÁNGULO DE ATAQUE	7°	7°	2°	7°	7°	7°	7°	
				CALIDAD DEL METAL DURO	MICROGRANO							
DESCRIPCIÓN	DIN	AISI										
N	METALES PUROS, BLANDOS	400-800 (120-310 HB)	Hierro puro, plomo	1.1003	PLOMO	○	○	○	○	○	●	●
	ALEACIONES DE ALUMINIO, DE VIRUTA LARGA	100-400 (120-310 HB)	AlMg 3	3.3535	EN AW 5754	○	○	○	○	○	●	●
	ALEACIONES DE ALUMINIO, DE VIRUTA CORTA	-400	G-AISI 12	3.2581	G-AISI 12	○	○	○	○	○	●	●
	ALEACIONES DE COBRE, DE VIRUTA LARGA	150-250 (160-230 HB)	MS63	2.0320	Latón 63	○	○	○	○	○	●	●
	ALEACIONES DE COBRE, DE VIRUTA CORTA	-500	MS58	2.0402	Latón 58	○	○	○	○	○	●	●
	ALEACIONES DE MAGNESIO	160-300	G-MgAl9Zn1	3.5912	Magnesio Az 91 D	○	○	○	○	○	●	●
	TERMOPLÁSTICOS	300-700 (150-280 HB)	PVC, vidrio acrílico			○	○	○		○	●	●
	DUROPLÁSTICOS	20-40	Baquelita, melamina	1.1191	C1045	○	○	○			●	●
S	GRAFITO		Grafito	R8510	Grafito					○		
	ALEACIONES DE TITANIO, RESISTENCIA MEDIA	-950	TiAl5Sn2,5	3.7115	ASTM serie grado 6	○	○	○	●	○	○	○
			TiAl6V4	3.7165	ASTM B265	○	○	○	●			
	ALEACIONES DE TITANIO, RESISTENCIA ALTA	900-1400	TiAl6Sn2	3.7174	AMS 4971/ 4978	○	○	○	●	○	○	○
	ALEACIONES DE NÍQUEL, RESISTENCIA MEDIA	-950	NiCr12Al6MoNb	2.4670	Aleación 713 LC Inconel 713	○	○	○	●	○	○	○
	900-1400	NiCr19Fe19NbMo		ASTM B637/ B670	○	○	○	●		○	○	
		Inconel 718			○	○	○	●				
H	FUNDICIÓN DURA	300-600	Ni-hard, Ampco	Ampco 25	Ampco 25	●	●	●	●		○	○
	ACERO TEMPLADO	45-52 HRC 53-59 HRC				○	○	●	●		○	○
						○	○	●	●			

● Muy adecuado ○ También utilizable

FRESAS

DE METAL DURO INTEGRAL

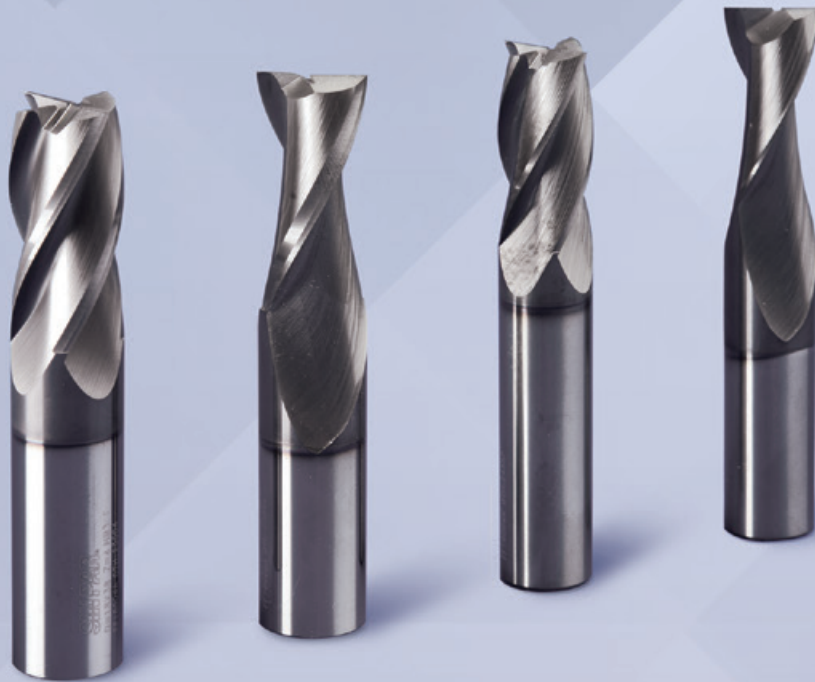



FRESAS PLANAS HÉLICE VARIABLE

PREMIUM, FRONTALES CON 4 FILOS

CARACTERÍSTICAS	
FORMA DE LA PUNTA	PLANA
TIPO	HÉLICE VARIABLE
NORMA	DIN 6527 A
CANTIDAD DE FILOS	Z = 4
ÁNGULO DE HÉLICE	$\lambda = 41^\circ$ a 44°
PASO	DESIGUAL
DESCARGA	REBAJE ENTRE FILO Y MANGO
SENTIDO DE CORTE	DERECHO
FRENTE	CORTE AL CENTRO
TIPO DE MANGO	CILÍNDRICO SEGÚN DIN 6535 A
LARGO DEL MANGO	SEGÚN TABLA
TOLERANCIA DEL MANGO	h6
CALIDAD DEL METAL DURO	MICROGRANO
RECUBRIMIENTO	R302
APLICACIONES	ACEROS INOXIDABLES CON NÍQUEL

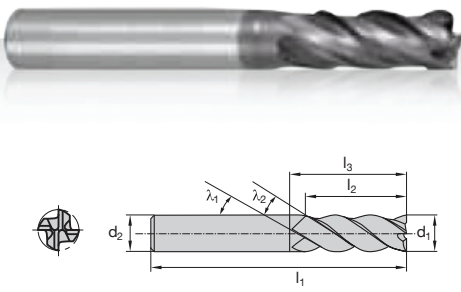
> 4 FILOS





TIPOS DE MANGO: XC: EXTRA CORTO L: LARGO SIN REFERECIA: LARGO ESTANDAR (CORTO)

CÓDIGO	DESCRIPCIÓN					R. EQUIV.	FILOS	DISPONIBILIDAD	ENVASE
	d ₁ mm	d ₂ mm	l ₁ mm	l ₂ mm	l ₃ mm				
FRMD-FP04004A-FHV	4,0	6	57	8	12	0,15	4	●	1 u
FRMD-FP05004A-FHV	5,0	6	57	10	15	0,20	4	●	1 u
FRMD-FP06004A-FHV	6,0	6	57	13	21	0,30	4	●	1 u
FRMD-FP08004A-FHV	8,0	8	63	19	27	0,30	4	●	1 u
FRMD-FP10004A-FHV	10,0	10	72	22	32	0,30	4	●	1 u
FRMD-FP12004A-FHV	12,0	12	83	26	38	0,30	4	●	1 u
FRMD-FP14004A-FHV	14,0	14	83	26	38	0,40	4	●	1 u
FRMD-FP16004A-FHV	16,0	16	92	32	44	0,40	4	●	1 u
FRMD-FP18004A-FHV	18,0	18	92	32	44	0,40	4	●	1 u
FRMD-FP20004A-FHV	20,0	20	104	38	54	0,40	4	●	1 u

● Producto estándar en stock ● Producto estándar a pedido ○ Producto especial a pedido